

H4074



GB | GoSmart IP Outdoor Camera IP-1300 LANTERN 4MPx



Contents

Instructions and Warnings	2
Package Contents	3
Technical Specifications.....	3
Device Description.....	4
Installation and Assembly.....	5
Pairing with the App.....	7
Troubleshooting FAQ.....	15

Instructions and Warnings



Read the user manual before using the device.



Follow the safety instructions provided in the manual.



Do not dispose of electrical appliances as unsorted municipal waste; use sorted waste collection points. Contact local authorities for up-to-date information about collection points. If electrical appliances are deposited in waste landfills, hazardous substances may leak into the groundwater, enter the food chain and harm your health.

Do not clean the exterior of the device using water or chemicals. Always use a dry cloth to avoid mechanical damage or injury by electric current.

Do not plug the power cable into the socket with wet or moist hands; risk of injury by electric current.

Do not disassemble, repair or modify the device yourself. Doing so may cause a fire, injury by electric current or irreversible damage.



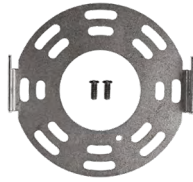

Package Contents

Camera
Camera mount
Fasteners
Quick guide

Technical Specifications

Power supply: AC 110-220 V/50-60 Hz
Maximum light output: 100 W
Bulb socket: E27
Dimensions: 130 × 195 × 290 mm
Weight: 2.5 kg
Resolution: 2,560 × 1,440
Sensor: MIS4001
Voice communication: Two-way (Full-Duplex)
Maximum motion detection range: 10 m
Motion detection angle: 110°
Maximum range of night vision: 10 m
Range of the camera's motorised pan: 220°
Range of manual camera tilt: 35°
Storage: SD card (max. 256 GB, FAT32),
cloud storage
Enclosure rating: IP44
Operating temperature: -20 °C – 60°C
APP: EMOS GoSmart for Android and iOS
Connection: 2.4 GHz Wi-Fi (IEEE 802.11b/g/n),
5 GHz Wi-Fi (IEEE 802.11b/g/n/ax)
Maximum e.i.r.p. 2.4 GHz: 15.31 dBm
Maximum e.i.r.p. 5 GHz: 12.9 dBm
Maximum e.i.r.p. BLE: -1.27 dBm





Device Description

- 1 – Microphone
- 2 - Lens
- 3 – LED illumination
- 4 – Reset button – Pressing and holding RESET for 5 s resets the device to factory settings.
- 5 – SD card slot



Installation and Assembly

Location Choice and Installation

First, carefully choose the location where the camera with light will be installed. Please make sure you have a strong enough Wi-Fi signal in this location. Cameras require a Wi-Fi signal strength of at least 60 % to ensure high-quality video and audio transmission. Otherwise, notifications may be delayed and the image and sound may stutter. Before proceeding with the installation, make sure that the wires connecting the camera to the light are not live. We recommend switching off the relevant circuit directly at the circuit breaker. This task should always be carried out by a qualified person.

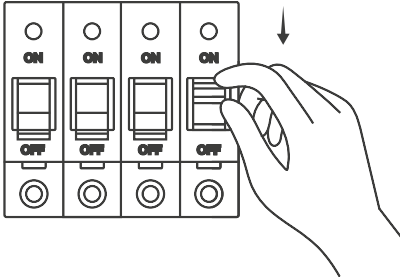

We recommend fitting a junction box in the wall beneath the camera with the light. Handling and connecting the wires is then considerably easier. Screw the circular metal mount to the wall using the enclosed fasteners. If you are installing the camera with the light on an insulated polystyrene façade, we recommend using chemical anchors to secure the mount, given the total weight of the camera and light. Then feed the supply cable through the central hole in the mount. The camera is fitted with three wires. First, connect the yellow-green protective conductor. Do not forget to connect the ground. Then connect the blue neutral conductor. Finally, connect the brown phase conductor.

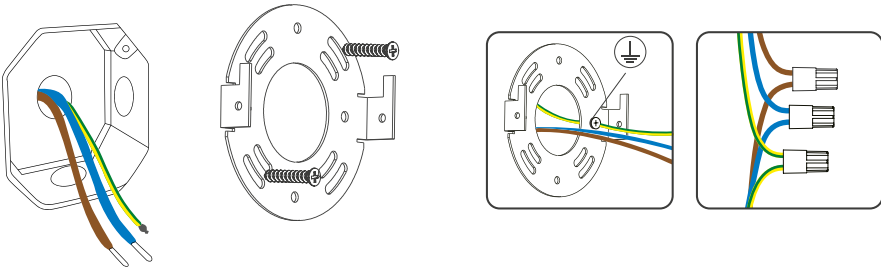

Once all the wires have been connected, fit the camera with light onto the mount and secure it by pushing it downwards. Then secure the camera and light in place with two screws from the side.

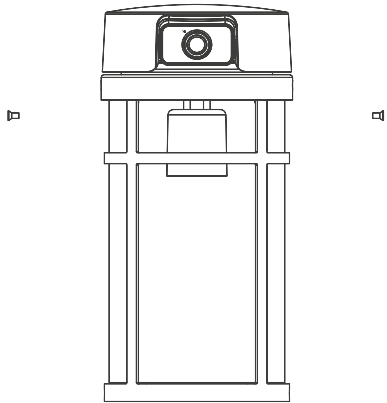
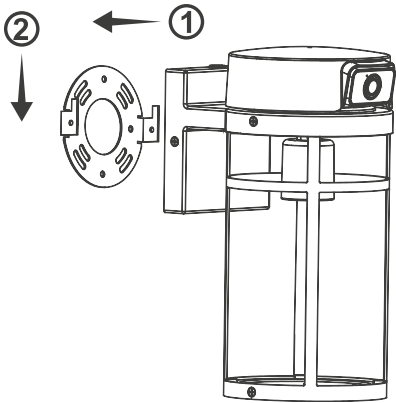

You can now screw the bulb into the light. Do not exceed the maximum permitted wattage of the bulb, which is 100 watts. The camera with light has an E27 thread.

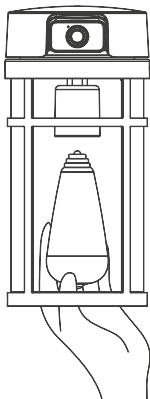

Commissioning the Camera with Light

Now connect the camera with light to power. Switch on the circuit breaker and wait a moment for the camera to move to its reference position and be ready to pair with the EMOS GoSmart app. Then remove the protective film from the camera lens.

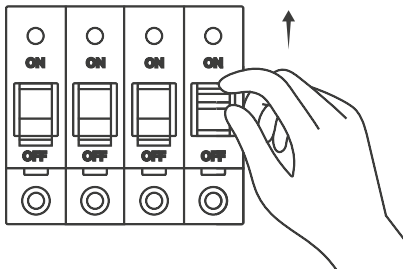

Pairing with the App

Installing the EMOS GoSmart App

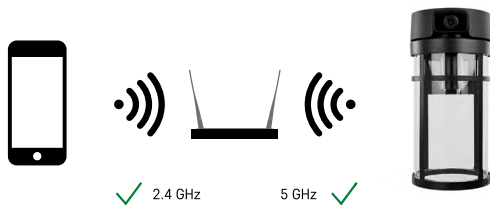

The IP-1300 LANTERN is a dual-band device and can communicate with a Wi-Fi router via both 2.4 GHz and 5 GHz networks.



The app is available for Android and iOS on Google Play and App Store. Download the app by scanning the QR code.

EMOS GoSmart Mobile App

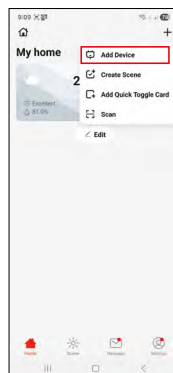
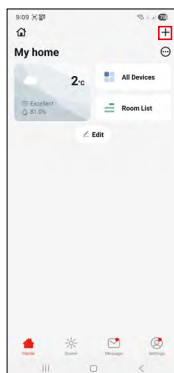
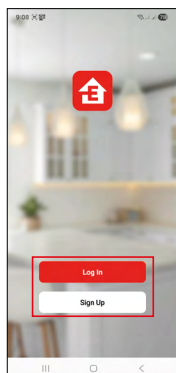
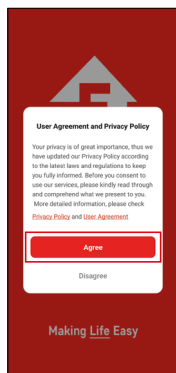

Open EMOS GoSmart and confirm the privacy policy by tapping Agree. Select "Sign Up", enter a valid e-mail address and choose a password. If you already have an account, select the "Log In" option. In the top right corner, tap on the "+" icon and select "Add device".

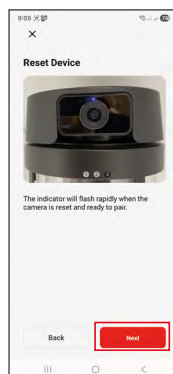
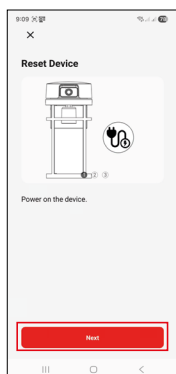

Now select the IP-1300 LANTERN camera from the GoSmart list. Follow the exact instructions in the app. Press and hold the "RESET" button for 5 seconds. Always use the "Next" button to proceed to the next step.

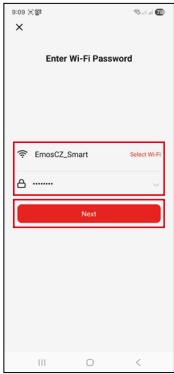

Please enter the details of your home Wi-Fi network. You must enter the name and password. These are case-sensitive. Then tap the "Next" button.
A QR code will appear on the screen of your device.
Place the QR code in front of the lens of the camera unit. Watch out for glare and sunlight.
Confirm that you have heard an audio signal for successful pairing.
The device will be detected automatically. Once the device has been found, confirm that you want to add it to the EMOS GoSmart app and tap the "Done" button.

Icons and Indicators

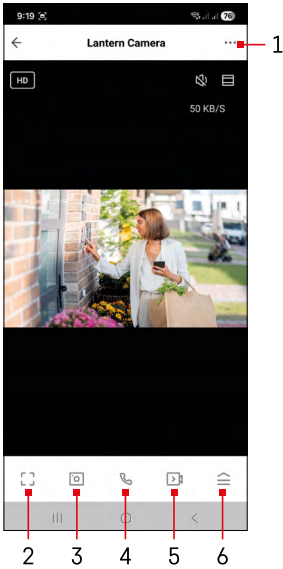

Description of Indicators in the Application

- 1 – access advanced settings
- 2 – fullscreen mode
- 3 – create a photo from live feed
- 4 – initiate a voice call
- 5 – start video recording
- 6 – access the menu of the camera with light

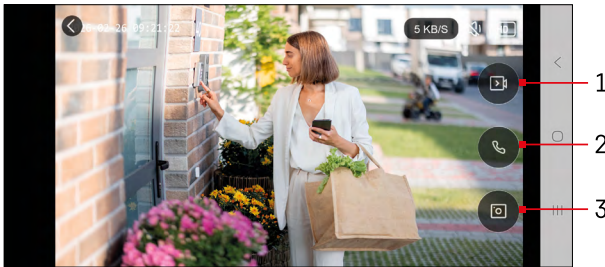





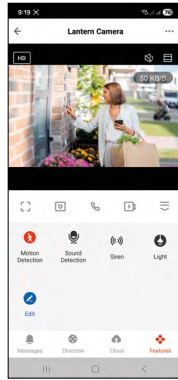
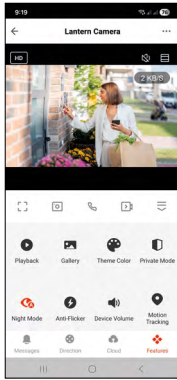

Fullscreen Mode

- 1 – start video recording
- 2 – initiate a voice call
- 3 – create a photo from live feed



...	Advanced settings (described in more detail in the next chapter)
HD	Switch video quality (HD / SD)
📶 98% 48 KB/S	Signal quality and speed
🔇	Mute
☰	Zoom
📐	Fullscreen mode
📷	Take pictures using the app and save them in the mobile album
🗣️	Talk
📹	Capture video using the app and save it in the mobile album
☰	Open the menu
▶️	Play video stored on the SD card
🎭	View videos and photos taken through the app
🎨	Light mode / dark mode
🏠	Private mode – the camera stops recording
🌙	Night mode settings. Recommended to set to AUTO.
📍	Motion tracking – the camera automatically follows a moving object
🚶	Motion detection – the camera will notify you if it detects any movement
🔧	Edit icons + option to add control for another device
★	Position settings (described in more detail in the next chapter)

	Manual camera movement
	Management and purchasing of cloud storage
	Display notifications (Motion detection...)
	Suppress flickering below a detectable threshold
	Volume setting
	Sound detection – the camera will notify you if it detects any loud sounds (crying, fall...)
	Turns on the camera's light

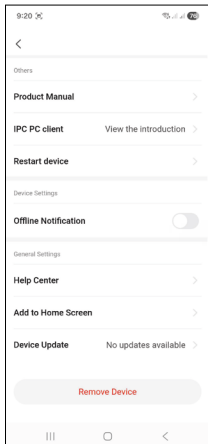
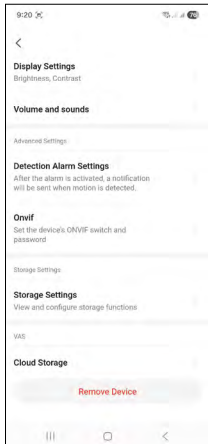
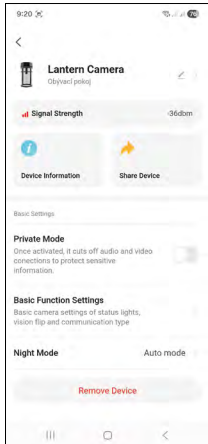

Description of Advanced Settings

- **Signal Strength** – Current signal strength in dBm (Excellent ≥ -50 dBm, Good -50 to -70 dBm, Sufficient -70 to -80 dBm, Poor < -80 dBm)
- **Device Information** – Basic information about the device and its owner
- **Share Device** – Option for sharing the administration of the device with another user
- **Private Mode** – Private mode settings
- **Basic Function Settings** – Option to turn on/off basic functions of the device such as automatic screen rotation or watermark with time and date. An important setting is also the option to choose between one-way or two-way communication.
- **Night Mode** – Night mode settings.
- **Display Settings** – Brightness and contrast settings
- **Volume and Sounds** – Volume settings
- **Detection Alarm Settings** – Alarm settings.
 - **Activity Area** – Sets the zone in which the camera will detect movement. For instance, if your camera is pointed towards a road and you do not want to be notified every time a car passes by, you can set which area the motion detection should focus on.
 - **Human Body Filtering** – Detection of human silhouettes. Once the function is activated, the device should no longer notify you of all movement, only if it detects a human body moving.
 - **Motion Tracking** – Track a moving object. If you enable this feature, the camera will track moving objects and record the entire movement sequence onto an SD card.
 - **Sound Detection** – Detection based on sound. Once this feature is enabled, you will receive a notification whenever the camera detects any sound.
- **Onvif** – Basic settings of the Onvif function for connecting the camera to external viewing devices, such as NVR systems.
- **Storage Settings** – Settings for the storage device
- **Cloud Storage** – Option to purchase standard cloud storage or an enhanced version featuring AI
- **Product Manual** – View the PDF user guide for the device
- **IPC PC Client** – Display web browser information for cameras
- **Restart Device** – Restarts the device
- **Help Center** – Displays frequently asked questions and their solutions and provides the option to send us a question/suggestion/feedback directly
- **Add to Home Screen** – Adds the icon for the device to the home screen of your phone. That way, you no longer need to open the device through the app every time; you simply tap the newly added icon and you will be redirected straight to the fountain menu
- **Remove Device** – Remove and unpair the device. An important step if you wish to change the owner of the device. Once a device is added to the app, the device is paired and cannot be transferred to another account without unpairing.

Recording onto an SD Card

One of the core functions of a home security system is the ability to record onto an SD card.

The camera supports SD cards with a maximum capacity of 256 GB in FAT32 format. Once the card is full, data will automatically start overwriting.

Instructions on how to activate the SD card function:

1. Insert the Micro SD card into the appropriate slot.
2. Open the device's advanced settings and choose the "Storage settings" options.
3. Format the SD card. ATTENTION: do not turn off the app or interrupt the process while the card is formatting.
4. Turn on the PIR sensor and set the desired sensitivity. You can also activate/deactivate human body recognition in the settings to prevent alarms whenever the camera registers an animal or tree moving. You can also use the "Activity Area" option to designate an area in which the camera should detect movement. (For example, if you do not want the camera to notify you whenever a car passes on a road that is within the camera's field of view).
5. When the camera detects movement, it will also record a few seconds of video, which you can then find under the  icon





Troubleshooting FAQ

The devices are not pairing. What should I do?

- Make sure the signal is sufficiently strong
- Give the app all permissions in the settings
- Check that you are using an up-to-date version of the mobile operating system and the latest version of the app

I can be heard outside but sound from the outside is not coming in / Sound from the outside is coming in but I cannot be heard outside.

- Check that you have given the app all permissions on your device, particularly microphone access.
- Another potential issue is one-way communication. If this icon  is displayed, it means the device is set to one-way communication.
- If you want to change the setting, go to "Basic Function Settings" and set "Talk Mode" to "Two-way Talk". You can find this menu in the advanced settings (see chapter "Description of Advanced Settings").
- The icon for two-way communication looks like this: 

I am not receiving notifications. Why?

- Give the app all permissions in the settings
- Turn on notifications in the app's settings (Settings -> App notifications)

What SD card can I use?

- The device supports SD cards up to a maximum storage capacity of 256 GB, and speed of at least CLASS 10 in FAT32 format.

When the SD card's memory is full, are the oldest recordings automatically overwritten or do I have to delete them manually?

- Yes, recordings are overwritten automatically.

Who is allowed to use the device?

- The device must always have an admin (owner)
- The admin can then share the device with other people in the household and assign them rights



GB | Safety information - Do not disassemble, modify, or repair the product or batteries (if the product contains batteries). - Contact a qualified technician if needed - Disconnect from power before cleaning. Clean only with a dry cloth. - Only use the original power cord and supply voltage listed on the label. - Never immerse the product or batteries (if the product contains batteries) in liquid. - Improper installation and/or use may cause electric shock or fire. Use only as intended.

CZ | Bezpečnostní pokyny - Výrobek ani baterie (pokud výrobek baterie obsahuje) nerozebírejte, neupravujte ani neopravujte. V případě potřeby se obraťte na kvalifikovaného technika. - Před čištěním odpojte přístroj od napájení. Čistěte pouze suchým hadříkem. - Používejte pouze originální napájecí kabel a napájecí napětí uvedené na štítku. - Nikdy neponořujte výrobek ani baterie (pokud výrobek baterie obsahuje) do kapaliny. - Nesprávná instalace nebo použití může způsobit úraz elektrickým proudem nebo požár. Používejte pouze v souladu s určením.

SK | Bezpečnostné pokyny - Výrobok ani batérie (ak výrobok obsahuje batérie) nerozoberajte, neupravujte ani neopravujte. V prípade potreby sa obráťte na kvalifikovaného technika. - Pred čistením odpojte prístroj od napájania. Čistite iba suchou handričkou. - Používajte iba originálny napájací kábel a napájacie napätie uvedené na štítku. - Nikdy neponořujte výrobok ani batérie (ak výrobok batérie obsahuje) do tekutiny. - Nesprávna inštalácia alebo použitie môže spôsobiť úraz elektrickým prúdom alebo požiar. Používajte len v súlade s určením.

PL | Instrukcje bezpieczeństwa - Nie rozbieraj, nie modyfikuj ani nie naprawiaj produktu ani baterii (jeśli produkt zawiera baterie). W razie potrzeby skontaktuj się z wykwalifikowanym technikiem. - Przed czyszczeniem odłącz urządzenie od zasilania. Czyść wyłącznie suchą szmatką. - Używaj wyłącznie oryginalnego kabla zasilającego i napięcia zasilania podanego na etykiecie. - Nigdy nie zanurzaj produktu ani baterii (jeśli produkt zawiera baterie) w płynach. - Nieprawidłowa instalacja lub użytkowanie może spowodować porażenie prądem elektrycznym lub pożar. Używaj wyłącznie zgodnie z przeznaczeniem.

HU | Biztonsági utasítások - Ne szerezle szét, ne módosítsa és ne javítsa a terméket vagy az akkumulátort (ha a termék akkumulátort tartalmaz). Szükség esetén forduljon szakképzett szakemberhez. - A tisztítás előtt válassza le a készüléket az áramellátásról. Csak száraz ruhával tisztítsa. - Csak az eredeti tápkábelt és a címkén feltüntetett tápfeszültséget használja. - Soha ne merítse a terméket vagy az akkumulátorokat (ha a termék akkumulátorokat tartalmaz) folyadékba. - A helytelen telepítés vagy használat áramütést vagy tüzet okozhat. Kizárólag rendeltetésszerűen használja.

SI | Varnostna navodila - Izdelka in baterij (če izdelek vsebuje baterije) ne razstavljajte, ne spreminjajte in ne popravljajte. Po potrebi se obrnite na usposobljenega serviserja. - Pred čiščenjem odklopite napravo iz omrežja. Čistite samo s suho krpo. - Uporabljajte samo originalni napajalni kabel in napetost, navedeno na etiketi. - Izdelka ali baterij (če izdelek vsebuje baterije) nikoli ne potaplajte v tekočino. - Nepravilna namestitve ali uporaba lahko povzroči električni udar ali požar. Uporabljajte samo v skladu z namenom.

RS|HR|BA|ME | Sigurnosne upute - Ne rastavljajte, ne modificirajte niti popravljajte proizvod ili baterije (ako proizvod sadrži baterije). Ako je potrebno, obratite se kvalificiranom tehničaru. - Prije čišćenja isključite uređaj iz napajanja. Čistite samo suhom krpom. - Koristite samo originalni kabel za napajanje i napon napajanja navedeno na naljepnici. - Nikada ne uranjajte proizvod ili baterije (ako proizvod sadrži baterije) u tekućinu. - Nepravilna instalacija ili uporaba mogu uzrokovati strujni udar ili požar. Koristite samo prema namjeni.

DE | Sicherheitshinweise - Das Produkt und die Batterien (falls im Produkt enthalten) dürfen nicht zerlegt, verändert oder repariert werden. Wenden Sie sich bei Bedarf an einen qualifizierten Techniker. - Trennen Sie das Gerät vor der Reinigung von der Stromversorgung. Reinigen Sie das Gerät nur mit einem trockenen Tuch. - Verwenden Sie nur das Original-Netzkaabel und die auf dem Typenschild angegebene Netzspannung. - Tauchen Sie das Produkt oder die Batterien (falls im Produkt enthalten) niemals in Flüssigkeiten. - Eine unsachgemäße Installation oder Verwendung kann zu Stromschlägen oder Bränden führen. Verwenden Sie das Produkt nur bestimmungsgemäß.

UA | Інструкції з техніки безпеки - Не розбирайте, не модифікуйте та не ремонтуйте виріб або батареї (якщо виріб містить батареї). У разі необхідності зверніться до кваліфікованого технічного спеціаліста. - Перед чистенням від'єднайте прилад від джерела живлення. Чистіть тільки сухою ганчіркою. - Використовуйте тільки оригінальний кабель живлення та напругу живлення, зазначену на етикетці. - Ніколи не занурюйте виріб або батареї (якщо виріб містить батареї) у рідину. - Неправильна установка або використання може призвести до ураження електричним струмом або пожежі. Використовуйте тільки за призначенням.

RO|MD | Instrucțiuni de siguranță - Nu dezasmblați, modificați sau reparați produsul sau bateriile (dacă produsul conține baterii). Dacă este necesar, adresați-vă unui tehnician calificat. - Înainte de curățare,

deconectați aparatul de la sursa de alimentare. Curățați numai cu o cârpă uscată. - Utilizați numai cablul de alimentare original și tensiunea de alimentare indicată pe etichetă. - Nu scufundați niciodată produsul sau bateriile (dacă produsul conține baterii) în lichide. - Instalarea sau utilizarea incorectă poate provoca electrocutare sau incendiu. Utilizați numai în conformitate cu destinația prevăzută.

LT | Saugos instrukcijos - Negalima išardyti, modifikuoti ar remontuoti produkto ar baterijų (jei produktas turi baterijas). Jei reikia, kreipkitės į kvalifikuotą techniką. - Prieš valydami, atjunkite prietaisą nuo maitinimo. Valykite tik sausa šluoste. - Naudokite tik originalų maitinimo laidą ir maitinimo įtampą, nurodytą etiketėje. - Niekada nenaudokite produkto ar baterijų (jei produktas turi baterijas) skysčiuose. - Netinkamas montavimas ar naudojimas gali sukelti elektros smūgį ar gaisrą. Naudokite tik pagal paskirtį.

LV | Drošības instrukcijas - Nekādā gadījumā neizjauciet, nepārveidojiet vai nelabojiet izstrādājumu vai baterijas (ja izstrādājumā ir baterijas). Ja nepieciešams, sazinieties ar kvalificētu tehniķi. - Pirms tīrīšanas atvienojiet ierīci no strāvas padeves. Tīriet tikai ar sausu drānu. - Izmantojiet tikai oriģinālo strāvas vadu un uz etiķetes norādīto strāvas spriegumu. - Nekad nemērcējiet produktu vai baterijas (ja produktā ir baterijas) šķidrumā. - Nepareiza uzstādīšana vai lietošana var izraisīt elektriskās strāvas triecienu vai ugunsgrēku. Lietojiet tikai atbilstoši paredzētajam mērķim.

EE | Ohutusjuhised - Ärge toodet ega patareisid (kui toode sisaldab patareisid) lahti võtke, muutke ega parandage. Vajaduse korral pöörduge kvalifitseeritud tehniku poole. - Enne puhastamist ühendage seade vooluvõrgust lahti. Puhastage ainult kuiva lapiga. - Kasutage ainult originaalvoolikaablit ja toitepinget, mis on märgitud sildil. - Ärge kunagi kaste toodet ega patareisid (kui toode sisaldab patareisid) vedelikku. - Ebaõige paigaldamine või kasutamine võib põhjustada elektrilöögi või tulekahju. Kasutage ainult ettenähtud otstarbel.

BG | Инструкции за безопасност - Не разглобявайте, не променяйте и не ремонтирайте продукта или батериите (ако продуктът съдържа батерии). При необходимост се обърнете към квалифициран техник. - Преди почистване изключете уреда от захранването. Почиствайте само с суха кърпа. - Използвайте само оригиналния захранващ кабел и захранващото напрежение, посочено на етикета. - Никога не потапяйте продукта или батериите (ако продуктът съдържа батерии) в течност. - Неправилната инсталация или употреба може да доведе до токов удар или пожар. Използвайте само по предназначение.

FR|BE | Consignes de sécurité - Ne démontez pas, ne modifiez pas et ne réparez pas le produit ou les piles (si le produit en contient). Si nécessaire, contactez un technicien qualifié. - Débranchez l'appareil avant de le nettoyer. Nettoyez-le uniquement avec un chiffon sec. - Utilisez uniquement le câble d'alimentation d'origine et la tension d'alimentation indiquée sur l'étiquette. - Ne plongez jamais le produit ou les piles (si le produit en contient) dans un liquide. - Une installation ou une utilisation incorrecte peut entraîner un choc électrique ou un incendie. Utilisez uniquement conformément à l'usage prévu.

IT | Istruzioni di sicurezza - Non smontare, modificare o riparare il prodotto o le batterie (se presenti). Se necessario, rivolgersi a un tecnico qualificato. - Prima di pulire l'apparecchio, scollegarlo dall'alimentazione. Pulire solo con un panno asciutto. - Utilizzare solo il cavo di alimentazione originale e la tensione di alimentazione indicata sull'etichetta. - Non immergere mai il prodotto o le batterie (se presenti) in liquidi. - Un'installazione o un utilizzo non corretti possono causare scosse elettriche o incendi. Utilizzare solo per l'uso previsto.

NL | Veiligheidsinstructies - Het product en de batterijen (indien aanwezig) mogen niet worden gedemonsteerd, aangepast of gerepareerd. Neem indien nodig contact op met een gekwalificeerde technicus. - Koppel het apparaat los van de stroomvoorziening voordat u het reinigt. Reinig het apparaat alleen met een droge doek. - Gebruik alleen de originele voedingskabel en de op het typeplaatje aangegeven voedingsspanning. - Dompel het product of de batterijen (indien aanwezig) nooit onder in vloeistof. - Onjuiste installatie of gebruik kan elektrische schokken of brand veroorzaken.

Gebruik het product uitsluitend voor het beoogde doel.

ES | Instrucciones de seguridad - No desmonte, modifique ni repare el producto ni las pilas (si el producto contiene pilas). En caso necesario, póngase en contacto con un técnico cualificado. - Desconecte el aparato de la fuente de alimentación antes de limpiarlo. Límpielo únicamente con un paño seco. - Utilice únicamente el cable de alimentación original y la tensión de alimentación indicada en la etiqueta. - Nunca sumerja el producto ni las pilas (si el producto las contiene) en líquidos. - Una instalación o un uso incorrectos pueden provocar descargas eléctricas o incendios. Utilícelo únicamente para los fines previstos.

PT | Instruções de segurança - Não desmonte, modifique ou repare o produto nem as baterias (se o produto contiver baterias). Se necessário, contacte um técnico qualificado. - Desligue o aparelho da alimentação antes

de o limpar. Limpe apenas com um pano seco. - Utilize apenas o cabo de alimentação original e a tensão de alimentação indicada na etiqueta. - Nunca mergulhe o produto ou as baterias (se o produto contiver baterias) em líquidos. - A instalação ou utilização incorreta pode causar choque elétrico ou incêndio. Utilize apenas de acordo com a finalidade prevista.

GR | CY | Οδηγίες ασφαλείας - Μην αποσυναρμολογείτε, τροποποιείτε ή επισκευάζετε το προϊόν ή τις μπαταρίες (εάν το προϊόν περιέχει μπαταρίες). Εάν είναι απαραίτητο, απευθυνθείτε σε εξειδικευμένο τεχνικό. - Πριν από τον καθαρισμό, αποσυνδέστε τη συσκευή από την τροφοδοσία ρεύματος. Καθαρίζετε μόνο με ένα στεγνό πανί. - Χρησιμοποιείτε μόνο το αυθεντικό καλώδιο τροφοδοσίας και την τάση τροφοδοσίας που αναγράφεται στην ετικέτα. - Μην βυθίζετε ποτέ το προϊόν ή τις μπαταρίες (εάν το προϊόν περιέχει μπαταρίες) σε υγρά. - Η ακατάλληλη εγκατάσταση ή χρήση μπορεί να προκαλέσει ηλεκτροπληξία ή πυρκαγιά. Χρησιμοποιείτε μόνο σύμφωνα με τον προορισμό.

SE | Säkerhetsinstruktioner - Produkten eller batterierna (om produkten innehåller batterier) får inte demonteras, modifieras eller repareras. Kontakta en kvalificerad tekniker vid behov. - Koppla bort enheten från strömförsörjningen före rengöring. Rengör endast med en torr trasa. - Använd endast originalströmkabeln och den spänning som anges på etiketten. - Sänk aldrig ned produkten eller batterierna (om produkten innehåller batterier) i vätska. - Felaktig installation eller användning kan orsaka elstötar eller brand. Använd endast i enlighet med avsedd användning.

FI | Turvallisuusohjeet - Älä pura, muokkaa tai korjaa tuotetta tai paristoja (jos tuote sisältää paristoja). Ota tarvittaessa yhteyttä pätevään teknikkoon. - Irrota laite virtalähteestä ennen puhdistusta. Puhdista vain kuivalla liinalla. - Käytä vain alkuperäistä virtajohtoa ja etiketissä ilmoitettua jännitettä. - Älä koskaan upota tuotetta tai paristoja (jos tuote sisältää paristoja) nesteeseen. - Väärä asennus tai käyttö voi aiheuttaa sähköiskun tai tulipalon. Käytä vain käyttötarkoituksen mukaisesti.

DK | Sikkerhedsinstruktioner - Produktet eller batterierne (hvis produktet indeholder batterier) må ikke adskilles, modificeres eller repareres. Kontakt en kvalificeret tekniker, hvis det er nødvendigt. - Frakobl apparatet fra strømforsyningen inden rengøring. Rengør kun med en tør klud. - Brug kun det originale netkabel og den netspænding, der er angivet på typeskiltet. - Produktet eller batterierne (hvis produktet indeholder batterier) må aldrig nedsænkes i væske. - Forkert installation eller brug kan forårsage elektrisk stød eller brand. Brug kun i overensstemmelse med det tilsigtede formål.

GB | Hereby, EMOS spol. s r.o., declares that the radio equipment type H4074 is in compliance with Directive 2014/53/EU. The full text of the EU declaration of conformity is available at the following internet address: <http://www.emos.eu/download>.

CZ | Tímto EMOS spol. s r.o. prohlašuje, že typ rádiového zařízení H4074 je v souladu se směrnicí 2014/53/EU. Úplné znění EU prohlášení o shodě je k dispozici na těchto internetových stránkách <http://www.emos.eu/download>. Zařízení lze provozovat na základě všeobecného oprávnění č. VO-R/10/05.2025-5 v platném znění.

SK | EMOS spol. s r.o. týmto vyhlasuje, že rádiové zariadenie typu H4074 je v súlade so smernicou 2014/53/EÚ. Úplné EÚ vyhlásenie o zhode je k dispozícii na tejto internetovej adrese: <http://www.emos.eu/download>.

PL | EMOS spol. s r.o. niniejszym oświadczam, że typ urządzenia radiowego H4074 jest zgodny z dyrektywą 2014/53/UE. Pełny tekst deklaracji zgodności UE jest dostępny pod następującym adresem internetowym: <http://www.emos.eu/download>

 Zgodnie z przepisami Ustawy o ZSEiE zabronione jest umieszczanie łącznie z innymi odpadami zużytego sprzętu oznakowanego symbolem przekreślonego kosza. Użytkownik, chcąc pozbyć się sprzętu elektronicznego i elektrycznego, jest zobowiązany do oddania go do punktu zbierania zużytego sprzętu. W sprzęcie nie znajdują się składniki niebezpieczne, które mają szczególnie negatywny wpływ na środowisko i zdrowie ludzi. Obecność w sprzęcie niebezpiecznych substancji, mieszanin oraz części składowych ma potencjalny (szkodliwy) wpływ dla środowiska i zdrowie ludzi.

HU | EMOS spol. s r.o. igazolja, hogy a H4074 típusú rádióberendezés megfelel a 2014/53/EU irányelvnek. Az EU-megfelelőségi nyilatkozat teljes szövege elérhető a következő internetes címen: <http://www.emos.eu/download>.

SI | EMOS spol. s r.o. potrjuje, da je tip radijske opreme H4074 skladen z Direktivo 2014/53/EU. Celotno besedilo izjave EU o skladnosti je na voljo na naslednjem spletnem naslovu: <http://www.emos.eu/download>

RS|HR|BA|ME | EMOS spol. s r.o. ovime izjavljuje da je radijska oprema tipa H4074 u skladu s Direktivom 2014/53/EU. Cjeloviti tekst EU izjave o sukladnosti dostupan je na sljedećoj internetskoj adresi: <http://www.emos.eu/download>.

DE | Hiermit erklärt EMOS spol. s r.o., dass der Funkanlagentyp H4074 der Richtlinie 2014/53/EU entspricht. Der vollständige Text der EU-Konformitätserklärung ist unter der folgenden Internetadresse verfügbar: <http://www.emos.eu/download>.

UA | Цим підприємство EMOS spol. s r.o. проголошує, що тип радіобладнання H4074 відповідає Директивам 2014/53/EU. Повний текст ЄС проголошення про відповідність можна знайти на цьому сайті <http://www.emos.eu/download>.

RO|MD | Prin prezenta, EMOS spol. s r.o. declară că tipul de echipamente radio H4074 este în conformitate cu Directiva 2014/53/UE. Textul integral al declarației UE de conformitate este disponibil la următoarea adresă internet: <http://www.emos.eu/download>.

LT | Aš, EMOS spol. s r.o. patvirtinu, kad radijo įrenginių tipas H4074 atitinka Direktyvą 2014/53/ES. Visas ES atitikties deklaracijos tekstas prieinamas šiuo interneto adresu: <http://www.emos.eu/download>.

LV | Ar šo EMOS spol. s r.o. deklarē, ka radioiekārta H4074 atbilst Direktīvai 2014/53/ES. Pilns ES atbilstības deklarācijas teksts ir pieejams šādā interneta vietnē: <http://www.emos.eu/download>.

EE | Käesolevaga deklareerib EMOS spol. s r.o. et käesolev raadioseadme tüüp H4074 vastab direktiivi 2014/53/EL nõuetele. ELi vastavusdeklaratsiooni täielik tekst on kättesaadav järgmisel internetiaadressil: <http://www.emos.eu/download>.

BG | С настоящото EMOS spol. s r.o. декларира, че този тип радиосъоръжение H4074 е в съответствие с Директива 2014/53/ЕС. Цялостният текст на ЕС декларацията за съответствие може да се намери на следния интернет адрес: <http://www.emos.eu/download>.

FR|BE | Le soussigné, EMOS spol. s r.o., déclare que l'équipement radioélectrique du type H4074 est conforme à la directive 2014/53/UE. Le texte complet de la déclaration UE de conformité est disponible à l'adresse internet suivante: <http://www.emos.eu/download>.

IT | Il fabbricante, EMOS spol. s r.o. dichiara che il tipo di apparecchiatura radio H4074 è conforme alla direttiva 2014/53/UE. Il testo completo della dichiarazione di conformità UE è disponibile al seguente indirizzo Internet: <http://www.emos.eu/download>.

NL | Hierbij verklaar ik, EMOS spol. s r.o., dat het type radioapparatuur H4074 conform is met Richtlijn 2014/53/EU. De volledige tekst van de EU-conformiteitsverklaring kan worden geraadpleegd op het volgende internetadres: <http://www.emos.eu/download>.

ES | Por la presente, EMOS spol. s r.o. declara que el tipo de equipo radioeléctrico H4074 es conforme con la Directiva 2014/53/UE. El texto completo de la declaración UE de conformidad está disponible en la dirección Internet siguiente: <http://www.emos.eu/download>.

PT | O(a) abaixo assinado(a) EMOS spol. s r.o. declara que o presente tipo de equipamento de rádio H4074 está em conformidade com a Diretiva 2014/53/UE. O texto integral da declaração de conformidade está disponível no seguinte endereço de Internet: <http://www.emos.eu/download>.

GR|CY | Με την παρούσα ο/η EMOS spol. s r.o. δηλώνει ότι ο ραδιοεξοπλισμός H4074 πληροί την οδηγία 2014/53/ΕΕ. Το πλήρες κείμενο της δήλωσης συμμόρφωσης ΕΕ διατίθεται στην ακόλουθη ιστοσελίδα στο διαδίκτυο: <http://www.emos.eu/download>.

SE | Härmed försäkrar EMOS spol. s r.o. att denna typ av radioutrustning H4074 överensstämmer med direktiv 2014/53/EU. Den fullständiga texten till EU-försäkran om överensstämmelse finns på följande webbadress: <http://www.emos.eu/download>.

FI | EMOS spol. s r.o. vakuuttaa, että radiolaitetyypin H4074 on direktiivin 2014/53/EU mukainen. EU-vatimustenmukaisuusvakuutuksen täysimittainen teksti on saatavilla seuraavassa internetosoitteessa: <http://www.emos.eu/download>.

DK | Hermed erklærer EMOS spol. s r.o., at radioudstyrstypen H4074 er i overensstemmelse med direktiv 2014/53/EU. EU-overensstemmelseserklæringens fulde tekst kan findes på følgende internetadresse: <http://www.emos.eu/download>.